

### 315 ZÁHLBNÍK 45° NA STOPKU S10

HW

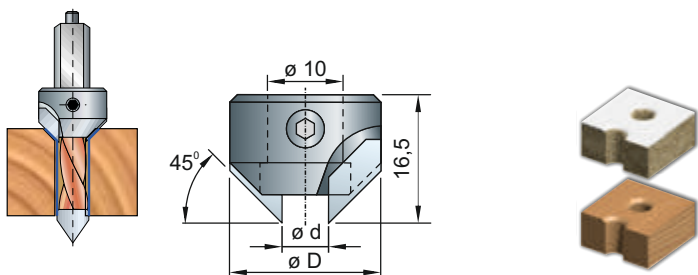

ø d	ø D	Nr RH	Nr LH
5 - 10	20	231.315.200.11	231.315.200.12
11 - 12	22	231.315.220.11	231.315.220.12



45°záhlbník sa upevňuje na stopku hlavne priebežných vrtákov so stopkou Ø10mm. Pri použití na kolíkovacom vrtáku nie je možné dĺžkové nastavenie záhlbníka na vrtáku.

### 316 ZÁHLBNÍK 45° NA TELO VRTÁKA

HW



ø d	ø D	Nr RH	Nr LH
4	15,5	231.316.040.11	231.316.040.12
5	15,5	231.316.050.11	231.316.050.12
6	15,5	231.316.060.11	231.316.060.12
7	18	231.316.070.11	231.316.070.12
8	18	231.316.080.11	231.316.080.12
9	18	231.316.090.11	231.316.090.12
10	20	231.316.100.11	231.316.100.12
12	22	231.316.120.11	231.316.120.12

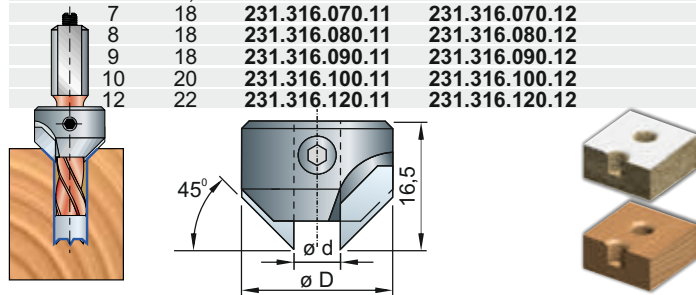

45°záhlbník sa upevňuje na telo vrtáka. Umožňuje jeho zafixovanie na požadovanej dĺžke kolíkovacích aj priebežných vrtákov. Priemer záhlbníka musí byť totožný s priemerom vrtáka.

### P094 ZÁHLBNÍK 45° SOLID

HW

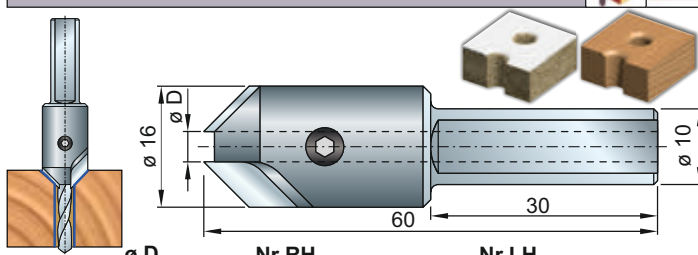

ø D	Nr RH	Nr LH
3	235P094M30AAAAAR	235P094M30AAAAAL
3,5	235P094M35AAAAAR	235P094M35AAAAAL
4	235P094M40AAAAAR	235P094M40AAAAAL
4,5	235P094M45AAAAAR	235P094M45AAAAAL
5	235P094M50AAAAAR	235P094M50AAAAAL
5,5	235P094M55AAAAAR	235P094M55AAAAAL
6	235P094M60AAAAAR	235P094M60AAAAAL

45°záhlbník s upínacou stopkou s ploškou, pre vložený vrták. V kombinácii s vrtákom SOLID ide o univerzálnu kombináciu pre priebežné aj nepriebežné otvory so zahĺbením.

### P080 ZÁHLBNÍK STUPŇOVITÝ 90° SOLID

HW

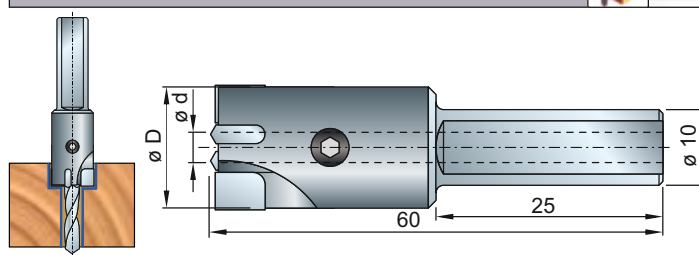

ø d	ø D	Nr RH	Nr LH
4	10	235P080M0410R	235P080M0410L
4	12	235P080M0412R	235P080M0412L
5	12	235P080M0512R	235P080M0512L
5	16	235P080M0516R	235P080M0516L
6	15	235P080M0615R	235P080M0615L
6	20	235P080M0620R	235P080M0620L

Plochý záhlbník na telo vrtáka pre stupňovité otvory. Umožňuje jeho zafixovanie na požadovanej dĺžke kolíkovacích aj priebežných vrtákov. Vnútny priemer záhlbníka musí byť totožný s priemerom vrtáka.



### 0639 ZÁHLBNÍK NÁSTRČNÝ 45°

FISCH

HSS



ø d	ø D	Nr
4	16	231F06390300
4	16	231F06390400
5	16	231F06390500
6	16	231F06390600
7	20	231F06390700
8	20	231F06390800
10	20	231F06391000
12	25	231F06391200

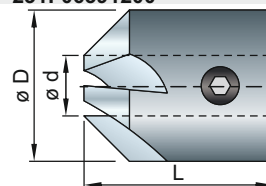

HSS záhlbník Z=5 vhodný pre všetky druhy HSS špirálových vrtákov nominálnych rozmerov.



### 0636 ZÁHLBNÍK NÁSTRČNÝ PLOCHÝ

FISCH

HSS



ø d	ø D	L	Nr
5	14	22	231F0636050140
5	15	22	231F0636050150
6	15	22	231F0636060150
8	16	25	231F0636080160
8	20	25	231F0636080200
8	25	25	231F0636080250
10	20	25	231F0636100200
10	25	25	231F0636100250
10	30	25	231F0636100300
12	25	25	231F0636120250
12	30	28	231F0636120300
12	35	32	231F0636120350
12	40	32	231F0636120400
12	45	38	231F0636120450

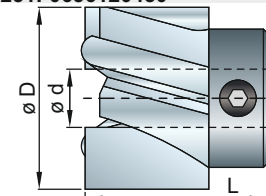

HSS záhlbník Z=2+2 vhodný pre všetky druhy HSS špirálových vrtákov nominálnych rozmerov.



**0600**  
**ZÁHLBNÍK STOPKOVÝ 45°**

FISCH SP



ø D	L	ø d	Nr
10	90	6	231F060001000
12	90	6	231F060001200
13	90	6	231F060001300
16	90	6	231F060001600
18	90	6	231F060001800
20	90	8	231F060002000
25	90	10	231F060002500

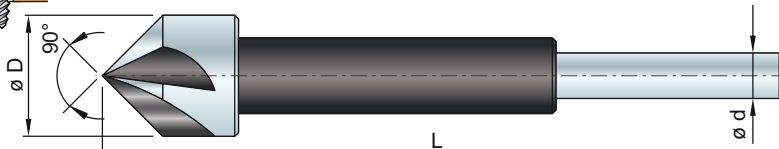
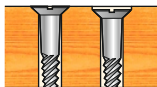

Záhlbník z nástrojovej ocele Z=5, určený pre zahlbovanie a zrážanie hrán otvorov v mäkkých a tvrdých drevinách.



**0606**  
**ZÁHLBNÍK STOPKOVÝ 45° EASY**

FISCH HSS



ø D	L	ø d	Nr
10,4	50	6	231F0606010401
12,4	56	8	231F0606012401
16,5	60	10	231F0606016501
20,5	63	10	231F0606020501
25	67	10	231F0606025001

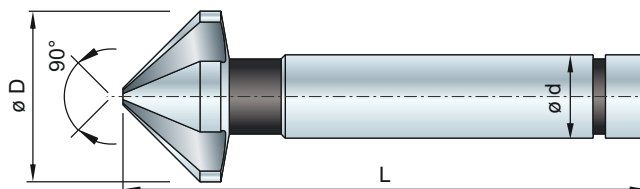
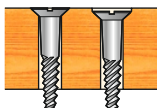

Priemyselný záhlbník pre zahlbovanie a zrážanie hrán otvorov bez otrepov s vysokými požiadavkami na kvalitu. Vhodný aj na neželezné kovy a oceľ.



**060XEM**  
**ZÁHLBNÍK STOPKOVÝ 45° EASY - BIT**

FISCH HSS



ø D	L	Nr
10,4	36	231F060XEM104
12,4	36	231F060XEM124
16,5	40	231F060XEM165
20,5	40	231F060XEM205

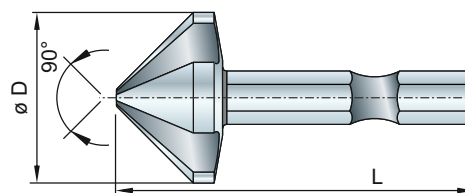
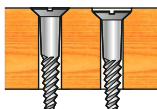

Priemyselný záhlbník pre zahlbovanie a zrážanie hrán otvorov bez otrepov s vysokými požiadavkami na kvalitu. Vhodný aj na neželezné kovy a oceľ.

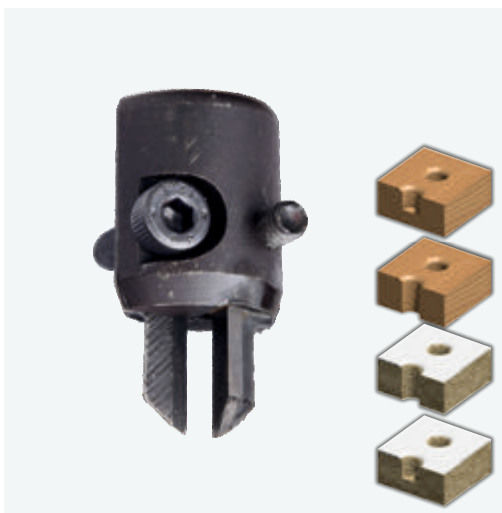

**A199**  
**ZÁHLBNÍK 45° NASTAVITELNÝ**

HW



ø D1	ø D2	B	L	Nr
3 - 7	11 - 15	12	32	606A199030R

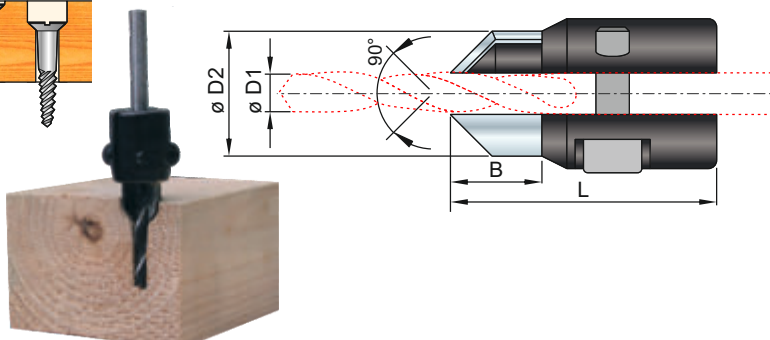
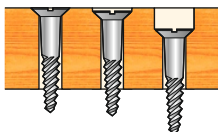

Záhlbník je možné nastříciť na vrtáky priemeru 3~7mm. Vyhotovenie záhlbníka umožňuje súčasným vrtaním zahlbovať a zapúšťať do hĺbky 12mm.



**063ASW**  
**ZÁHLBNÍK PLOCHÝ NA TESÁRSKE VRTÁKY**

FISCH

SP



ø D	B	L	ø d	Nr
40	15	38	12	231F063ASW12040
45	15	38	12	231F063ASW12045
50	17	38	12	231F063ASW12050
62	20	38	12	231F063ASW12062
65	21	38	12	231F063ASW12065
75	23	38	12	231F063ASW12075
85	25	40	12	231F063ASW12085

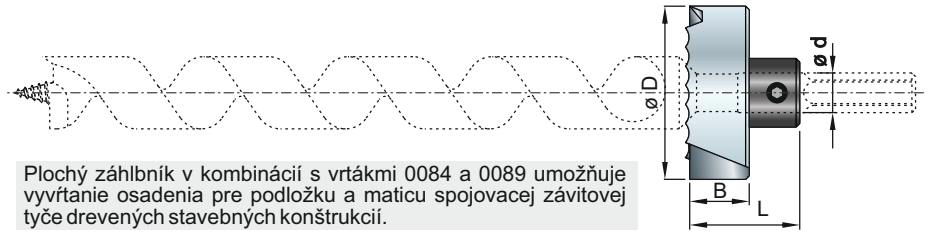

Ploché záhlbník v kombinácii s vrtákmi 0084 a 0089 umožňuje vyvrtanie osadenia pre podložku a maticu spojovacej závitovej tyče drevených stavebných konštrukcií.

**629Z**  
**PREDLŽOVACIE TYČE**

FISCH

ø D	ø d	L	Nr
20	12	300	231F629Z0030084
26	16	300	231F629Z00300841

