

SUPERPROFIL

HW

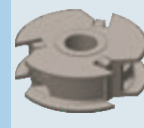
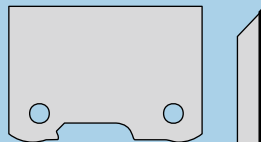

SUPERPROFIL

HW

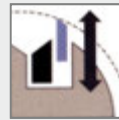
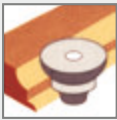
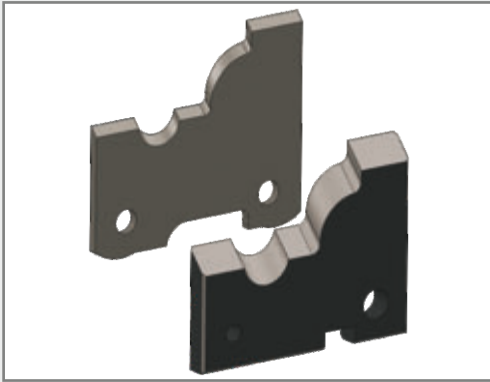

- profesionálne profilové nože pre obrábanie masívu a aglomerátov podľa použitého materiálu noža
- ustavovanie pomocou otvorov a kolíkov bez prípravkov a meradiel
- ostrenie po čele a chrbte
- nasadzovanie do frézovačiek so strojným posuvom
- **ceny sú uvedené za ľubovoľný profil** nezávisle na jeho zložitosti
- T10MG - tvrdokov určený pre obrábanie masívu
- T03SMG - tvrdokov určený pre obrábanie aglomerátov

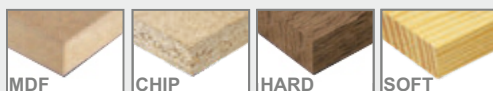
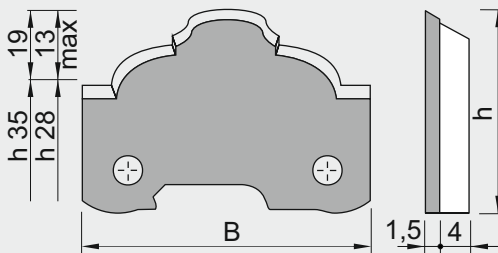
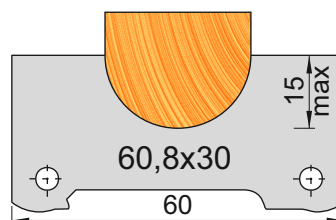
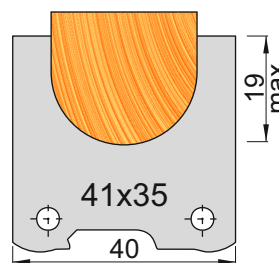
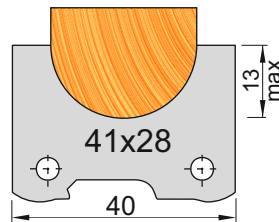
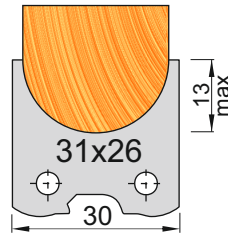

| TYP | | Nr |
|------------|--|----------|
| T10MG | | 54015211 |
| T03SMG | | 54015210 |
| oporný nôž | | 54015600 |

| TYP | | Nr |
|------------|--|----------|
| T10MG | | 54015727 |
| T03SMG | | 54015708 |
| oporný nôž | | 54015705 |

| TYP | | Nr |
|------------|--|----------|
| T10MG | | 54015753 |
| T03SMG | | 54015750 |
| oporný nôž | | 54015706 |

| TYP | | Nr |
|------------|--|----------|
| T10MG | | 54016225 |
| T03SMG | | 54016214 |
| oporný nôž | | 54016212 |

SUPERPROFIL TSP 154

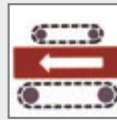
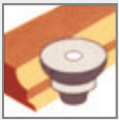
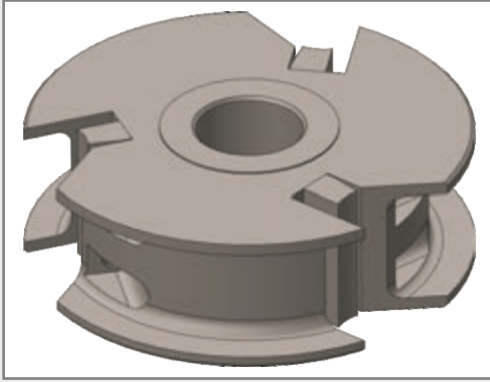

- priemyselné superprofilové hlavy pre strojný posuv
- nasadzovanie do spodných frézovačiek

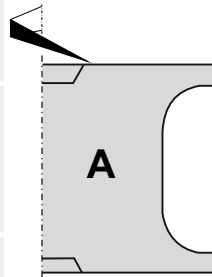
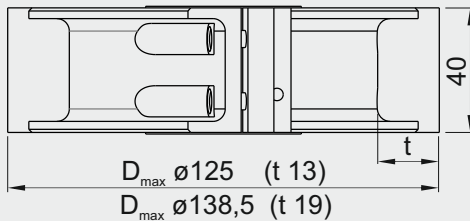
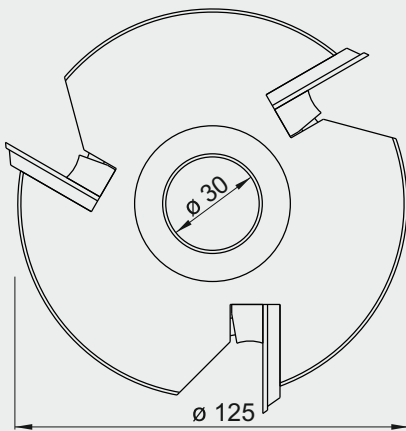

| TYP | ø D | ø d | Z | Nr |
|-----|-----|-----|---|------------|
| A | 125 | 30 | 3 | 280TSP154A |

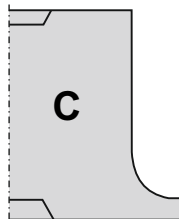

| TYP | ø D | ø d | Z | Nr |
|-----|-----|-----|---|------------|
| C | 125 | 30 | 3 | 280TSP154C |

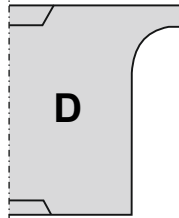

| TYP | ø D | ø d | Z | Nr |
|-----|-----|-----|---|------------|
| D | 125 | 30 | 3 | 280TSP154D |

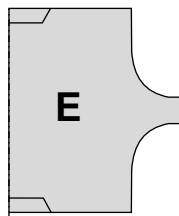

| TYP | ø D | ø d | Z | Nr |
|-----|-----|-----|---|------------|
| E | 125 | 30 | 3 | 280TSP154E |

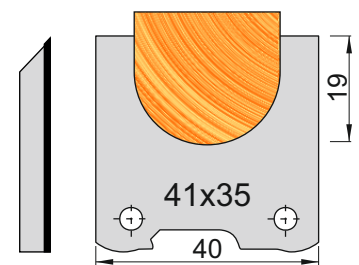
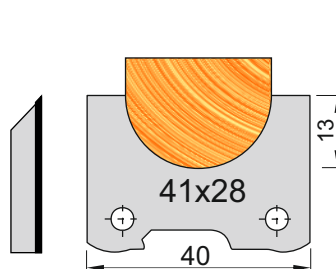

SUPERPROFIL TSP 156

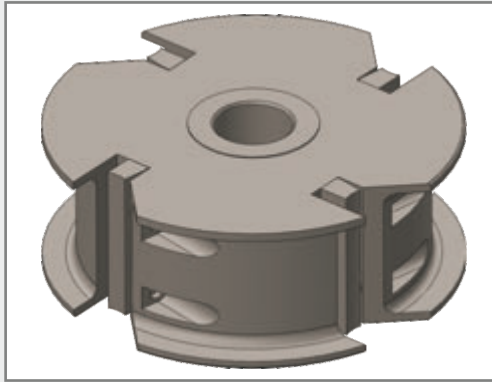

| $\varnothing D$ | $\varnothing d$ | Z | Nr |
|-----------------|-----------------|---|-----------|
| 160 | 40 | 4 | 280TSP156 |

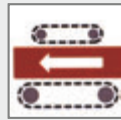
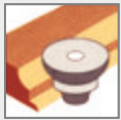

- priemyselné superprofilové hlavy pre strojný posuv
- nasadzovanie do štvorstranných frézovačiek

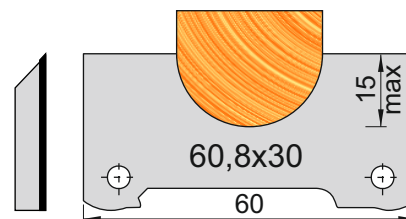
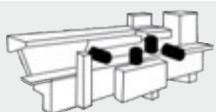
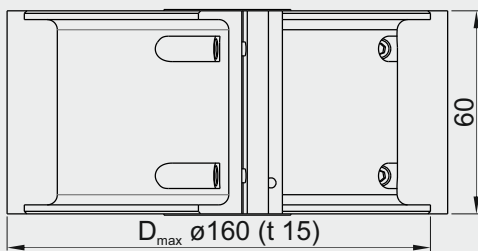
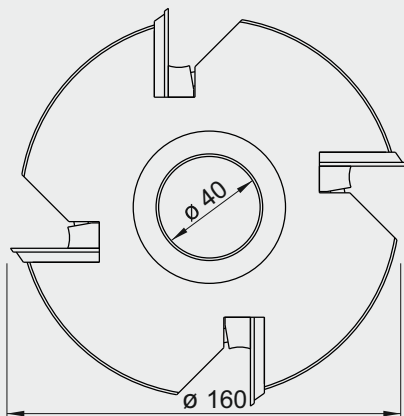

SUPERPROFIL HOBBY

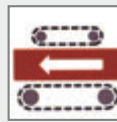
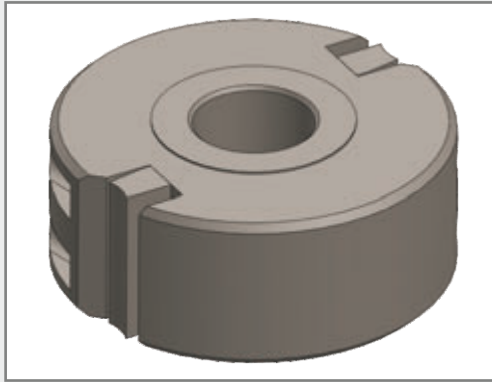



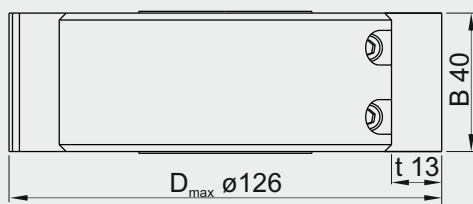
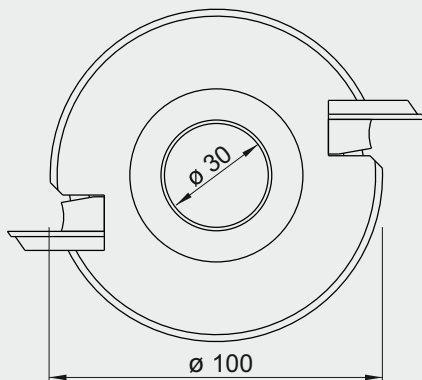



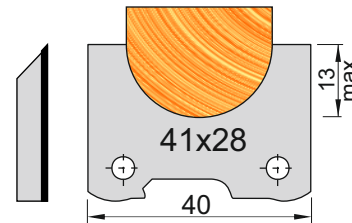

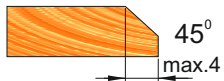
- priemyselné superprofilové hlavy pre strojný posuv
- nasadzovanie do spodných frézovačiek



| | | | |
|-----------------|-----------------|---|-------------|
| $\varnothing D$ | $\varnothing d$ | Z | Nr |
| 100 | 30 | 2 | 280TSP154AB |

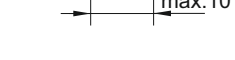

| Zaobľovanie | Zrážanie | Drážkovanie |
|---|---|--|
|  R 1,5 |  45° max.4 |  3 |
|  R 2 | |  4 |
|  R 3 | |  5 |
|  R 4 | |  max.10 |
|  R 5 | | |

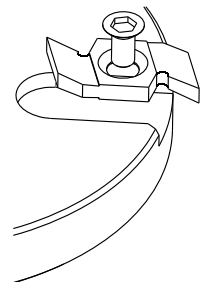
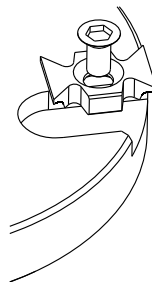

Do nosiča vyhotovujeme podľa individuálnych požiadaviek sedlá pre osadenie požadovaných elementov. Cena zahŕňa jedno sedlo, element a skrutku.

SUPERPROFIL TSP 155

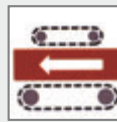
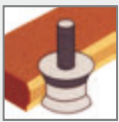
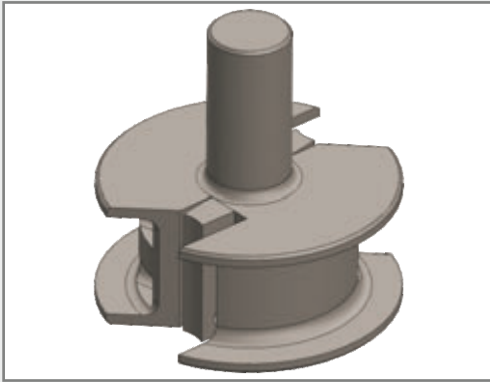

- priemyselné superprofilové hlavy pre strojný posuv
- nasadzovanie do obrábacích centier

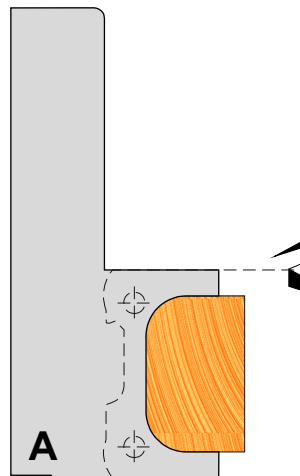
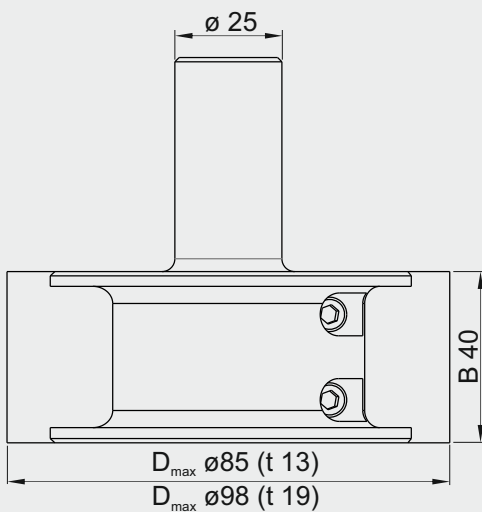

Nr
P 280TSP155A
L' 280TSP155AL

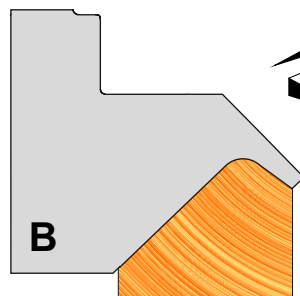

Nr
P 280TSP155B
L' 280TSP155BL

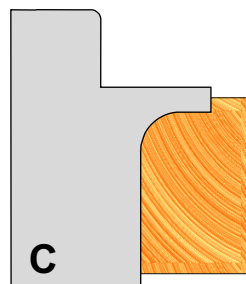

Nr
P 280TSP155C
L' 280TSP155CL

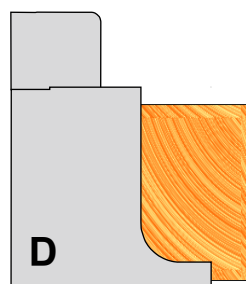

Nr
P 280TSP155D
L' 280TSP155DL

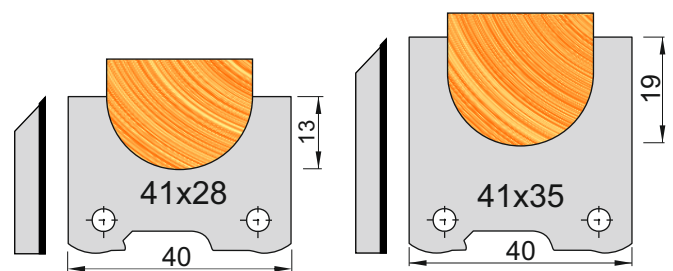

SUPERPROFIL TSP 152

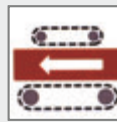

- priemyselné superprofilové hlavy pre strojný posuv
- nasadzovanie do obrábacích centier

| $\varnothing D$ | $\varnothing d$ | L | Nr |
|-----------------|-----------------|----|----------|
| 60 | 25 | 95 | 280TSP60 |

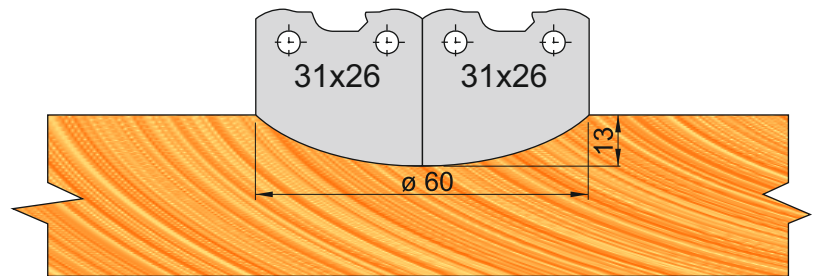

| $\varnothing D$ | $\varnothing d$ | L | Nr |
|-----------------|-----------------|----|----------|
| 80 | 25 | 95 | 280TSP80 |

