

accord 500 / accord 600

CNC machining centres for routing and drilling





ACCORDING TO WOOD

YOUR TIME MACHINES TO THE FUTURE



accord 500



accord 600

FREEDOM



Reduced overall dimensions and easy access to the work table for the operator, thanks to the **PRO-SPACE solution**, without perimeter safety protections.

PRODUCTIVITY



Considerably reduced cycle time with the exclusive **BRC-S unit**, that is even more flexible and compact, for all drilling, routing and grooving operations.

QUALITY



Perfect finishing even at high machining speeds with the new **17 kW-KPX 5-axis routing unit**.

Strength and precision in the most demanding stages of machining, thanks to the **gantry structure with closed frame and dual engine on the X-axis**.

INNOVATION



The exclusive, innovative and integrated **CADDY 35 tool changer** increases the amount of tools on board the machine, but with no extra space requirements.

CLEAN



Maximum dust extraction efficiency and cleanliness of the environment thanks to the **chip deflector device** automatically positioned according to the ongoing machining.

SMART MANAGEMENT

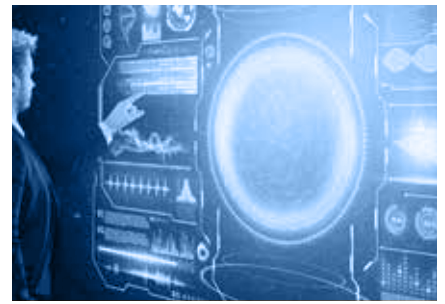

Optimized and simplified programming with **Maestro power TMS (Tool Management System)**: the software identifies and selects the tools according to the machining to be executed.

Maximum ergonomics in any condition with **Maestro easyLoad** that allows the operator to easily load and unload work pieces.

TECHNICAL FEATURES OVERVIEW

TECHNOLOGICAL ADVANTAGES



MATIC work table, with simultaneous positioning of rails, pods and clamps.



VELOCE 16 on-board tool changer, located on the operating unit, for tool changing in hidden time. A dedicated pick-up for large diameter saw-blades is available.



500

accord 500 / accord 600

CNC machining centres for routing and drilling



KPX 5-axis operating unit with 17kW electrospindle.



BRC-S operating unit for grooving, routing and drilling both vertically and horizontally.



PRO-SPACE version: reduced overall dimensions and safety granted by a bumpers system.



FAST 16 on-board linear tool changer located on board the mobile gantry to optimize tool changes. A dedicated pick-up for large diameter saw-blades is available.



CADDY 35 tool changer, integrated in the machine footprint.

TECHNICAL FEATURES OVERVIEW

TECHNOLOGICAL ADVANTAGES

PRO-SPEED protection system
for running the machine at
maximum feeding speed.



*Operating group with two
independent units, each one
equipped with its own on-board
tool changer.*



*MATIC work table, with
simultaneous positioning
of rails, pods and clamps.*

600

accord 500 / accord 600

CNC machining centres for routing and drilling



Coaxial integrated chip deflector device for maximum cleaning during machining when heavy material removal is required.



High performance drilling units with RO.AX (Rotoaxial Spindle Technology) spindles with high rotation speed, up to 8000 rpm.



TRC 32 chain tool changer, located on the rear side of the mobile gantry, allows for tool changing on both operating units.

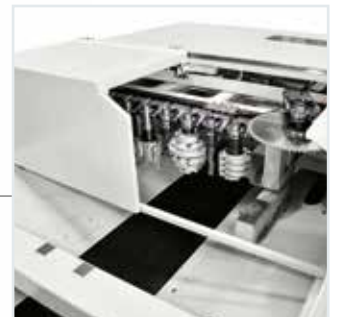

CADDY 35 tool changer, integrated in the machine footprint.

SAFETY SYSTEMS



“PRO-SPACE” PROTECTIONS

The loading zone is completely free, in order to optimize the space occupied by the machine. The absence of perimeter protections allows access to the work table from all sides of the machine.



accord 500 / accord 600

CNC machining centres for routing and drilling

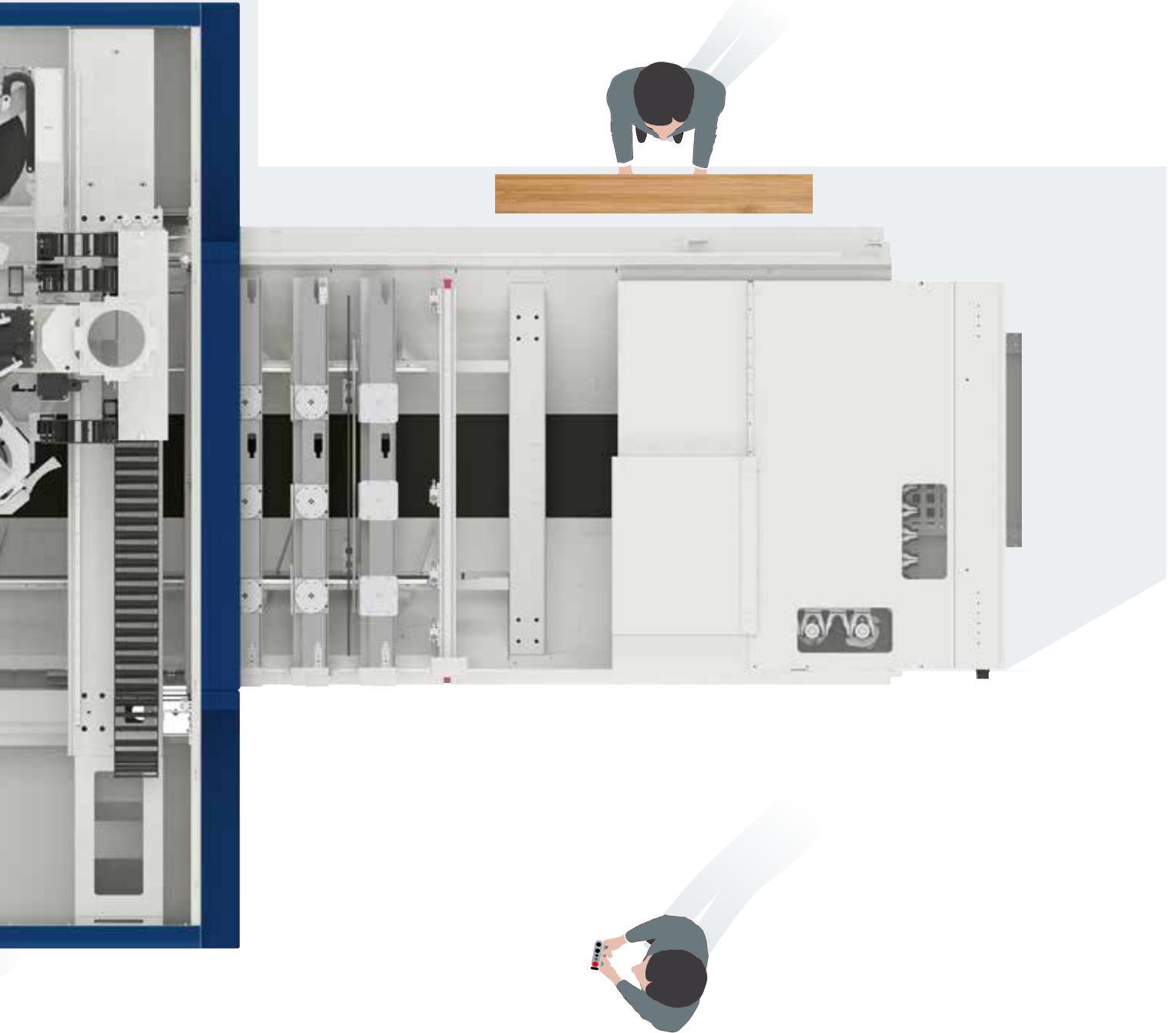

OPERATING UNIT

accord 500

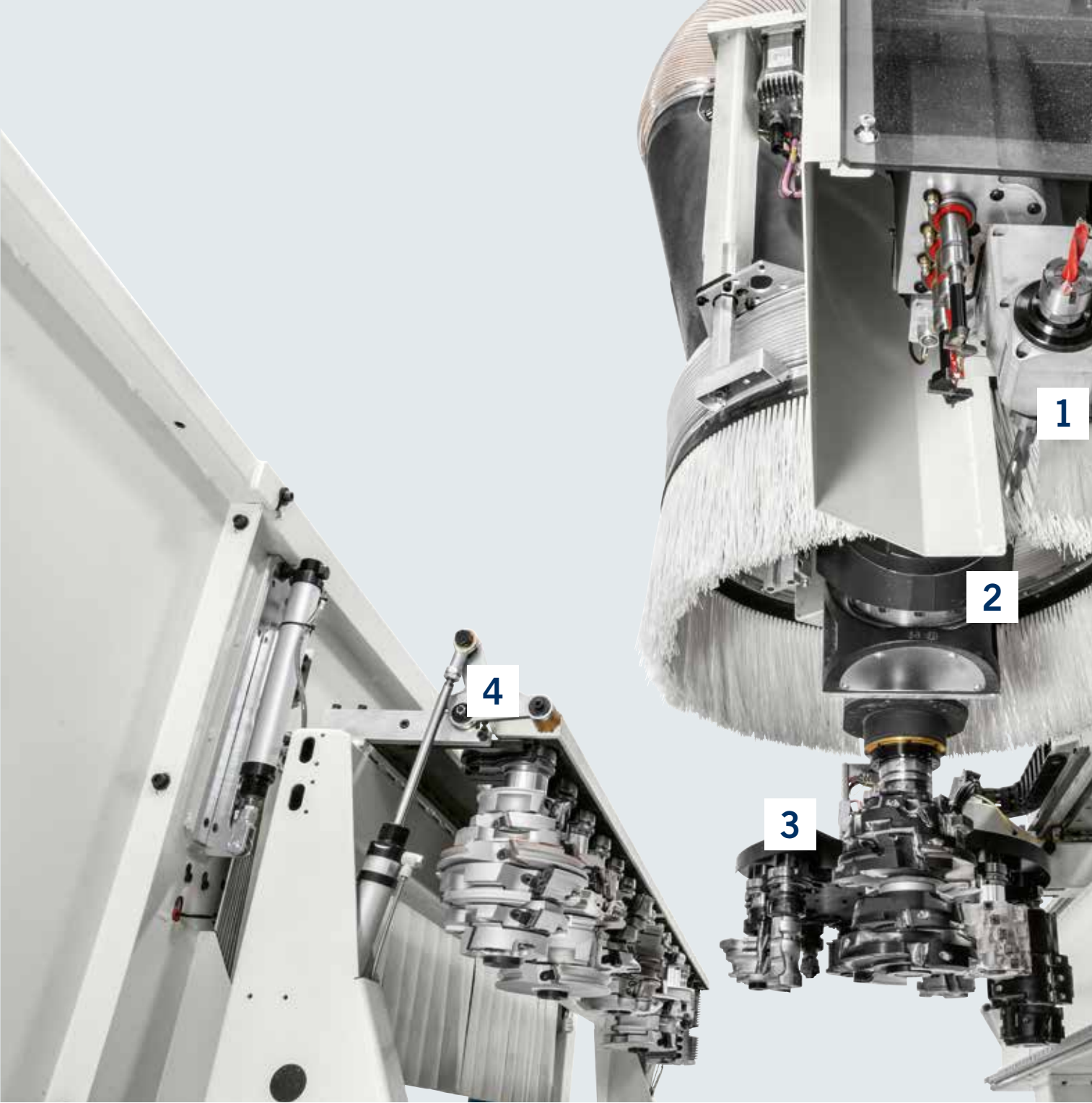

accord 500 / accord 600

CNC machining centres for routing and drilling



1

*The **BRC-S unit** allows to quickly and reliably perform all additional machining typical of window and door elements, such as grooving, drilling for dowels and horizontal routing. The 0-360° rotation, managed by Numerical Control, allows to perform the operations on each side of the work piece.*

2

*The **KPX 5-axis unit** with the 17 kW electrospindle enables the machine to increase the level of productivity, while maintaining high quality of finishing even at high processing speeds. The unique **TTS (Total Torque System)** by SCM mechanically locks the rotating axis in vertical position, increasing system stiffness.*

3

***VELOCE 16 on-board tool changer**, located on the operating unit, for tool changes in hidden time. A dedicated pick-up for large diameter saw-blades is available.*

4

***FAST 16 on-board linear tool changer** located on the mobile gantry to optimize tool changes. A dedicated pick-up for large diameter saw-blades is available.*

OPERATING UNIT

accord 600

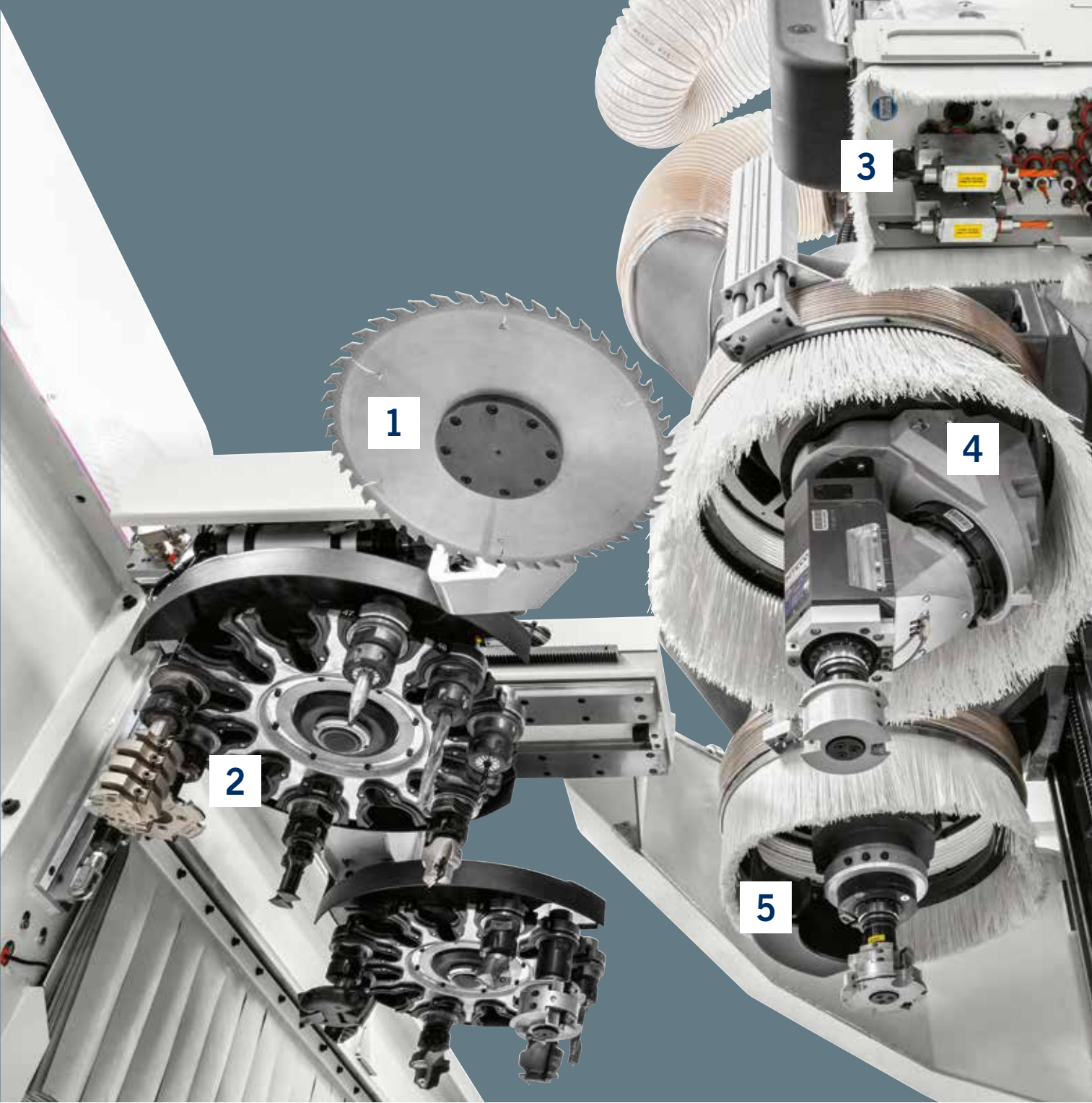

accord 500 / accord 600

CNC machining centres for routing and drilling



1 *Pick-up for saw-blade, located above the on-board tool changer, allows to house a large diameter saw-blade, up to 400 mm, in addition to the other tools. Thus, its footprint does not limit the capacity of the tool changer.*

2 *The 12-position “VELOCE” independent tool changers, each at the disposal of its own operating unit, allow for tool changing in hidden time.*

3 *High performance drilling units with RO.AX. (Rotoaxial Spindle Technology) spindles with high rotation speed, up to 8000 rpm.*

4 *The JQX 5-axis electrospindle, with direct drive and up to 13,5 kW power, ensures total absence of vibrations even with large material removals at high speeds.*

5 *3-axis rear routing unit, up to 21 kW power: always maximum power and machining speed in any conditions.*

TOOL CHANGERS



SHORTEST TIME FOR TOOL CHANGES: unique set-up with double electrospindle and double tool changer. While one head is machining the work piece, the second one is preparing the tool for the next machining operation.

Both tool changer and “cabinet” at disposal of the other tool changers on board the machine: CADDY 35 can house tools of large sizes and dimensions, loadable by the operator even during the machining, in hidden time and in complete safety.



No idle time for the tool change between one machining process and the next one thanks to the 16-position **FAST** tool changer.



SMART MANAGEMENT

Maestro power TMS



accord 500 / accord 600

CNC machining centres for routing and drilling

UP TO 102 TOOLS AVAILABLE ON BOARD

make the machine the best in its class!



High capacity of tools always available thanks to the 32-position **TRC rear tool changer**.

IT IS THE INNOVATIVE SOFTWARE STUDIED BY SCM that simplifies and optimizes tool management. It provides for loading the required tools on the on-board tool changers according to the programs the machine will execute.

SMART MANAGEMENT

GET THE BEST OF YOUR TIME

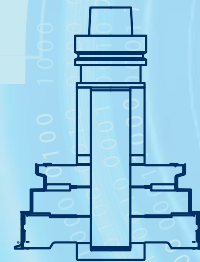

Maestro power TMS

Optimized programming with Maestro power TMS that maximizes the tool changers capacity and their management. The operator will no longer waste time searching for the most suitable tool - the software will find and indicate its right position.

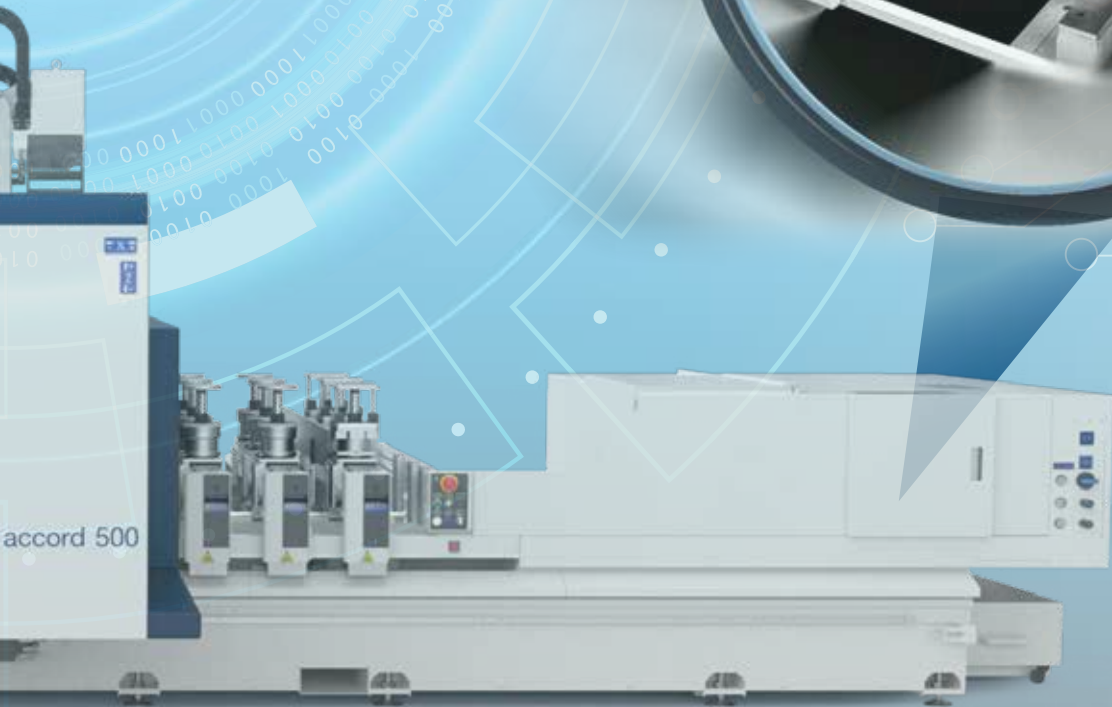
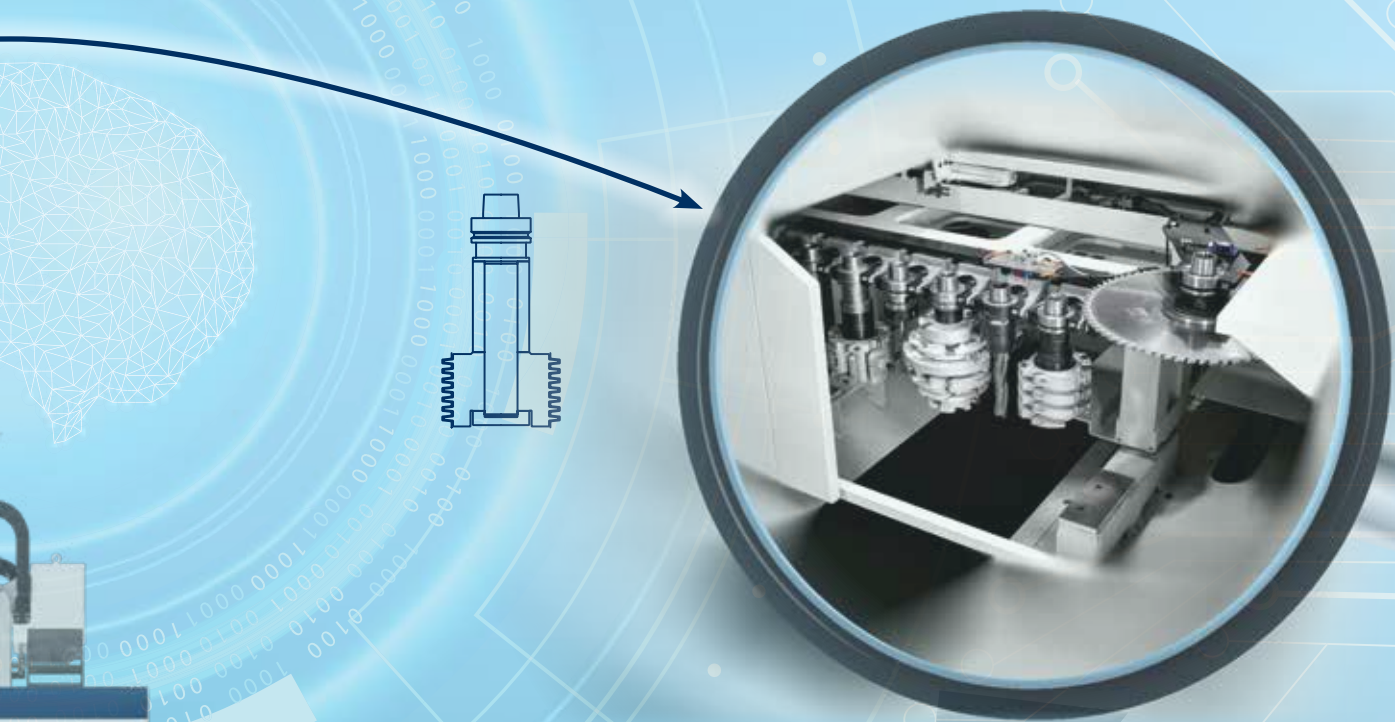

ARCHITECTURE

MOBILE GANTRY STRUCTURE

Maximum finish quality, accuracy and productivity: accord 500 and accord 600 are designed with a sturdy and highly ribbed mobile gantry structure.

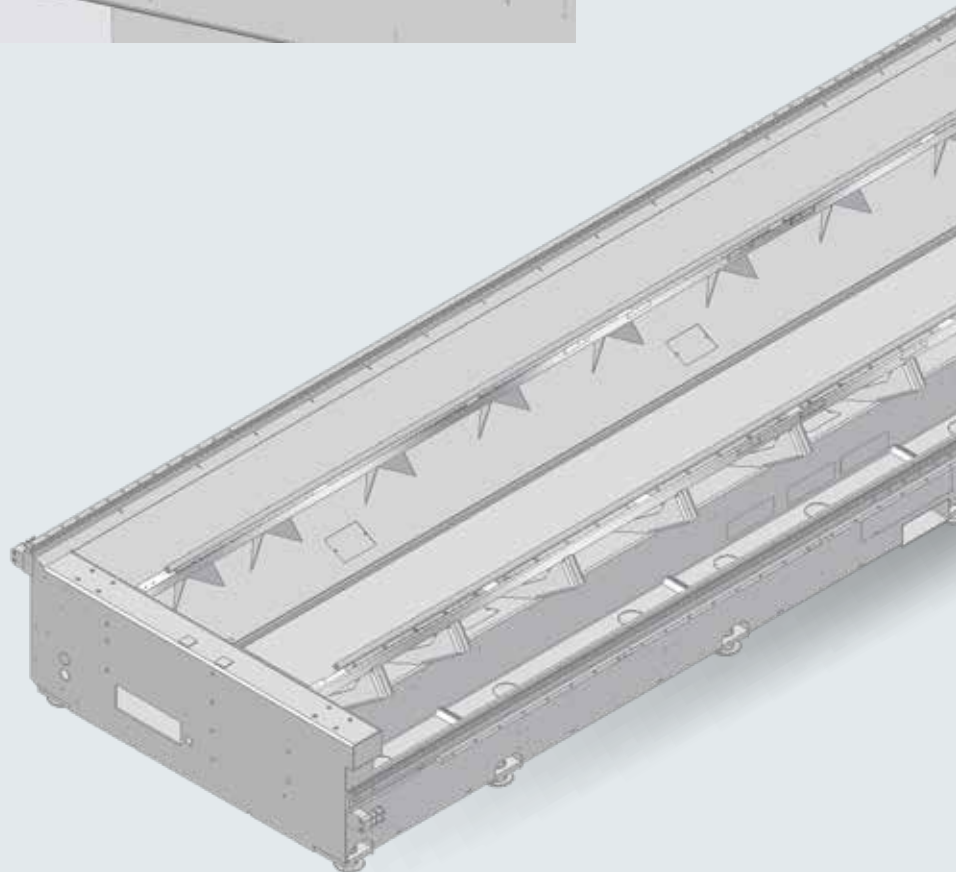
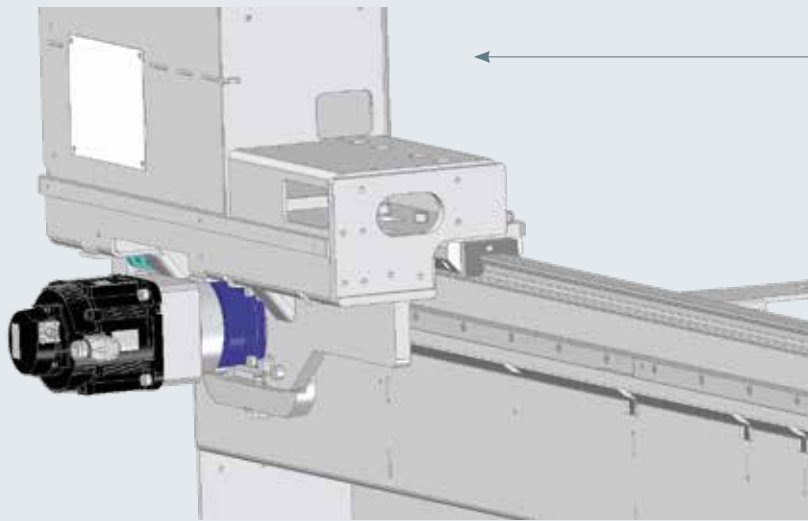

accord 500 / accord 600

CNC machining centres for routing and drilling

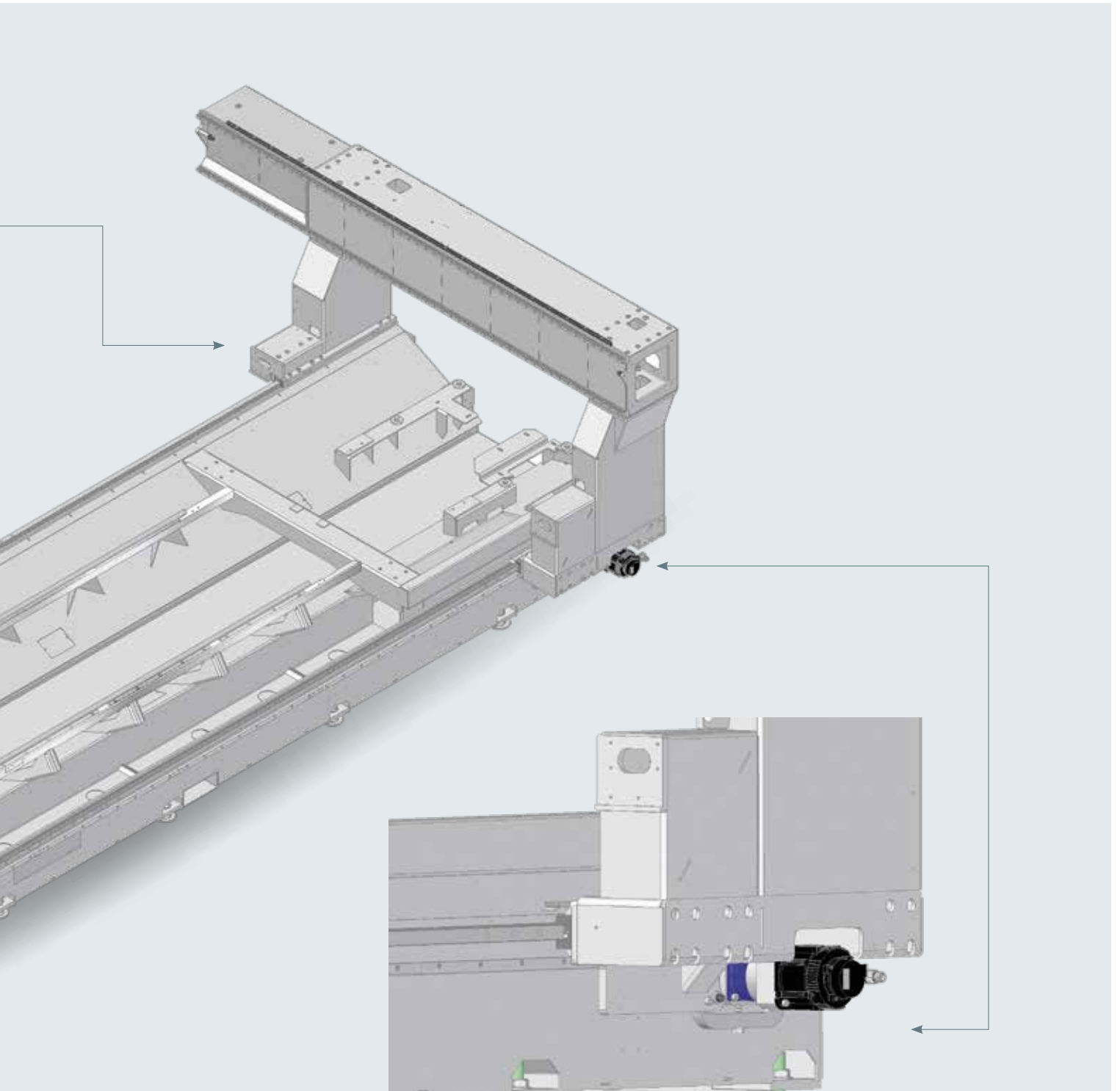

Maximum precision and fast movements:

X-axis sliding is carried out through a gantry system with double rack-and-pinion and twin motors.

WORK TABLE

A detailed close-up photograph of industrial machinery, likely a work table. The image shows several cylindrical rollers with red rings, mounted on a complex metal frame. The rollers are arranged in a row, and the machinery appears to be part of a larger automated system. The lighting is bright, highlighting the metallic surfaces and the red accents.

SET-UP IN HIDDEN TIME: TV MATIC WORK TABLE

The automatic work table ensures the **complete set-up in just a few seconds**. It is ideal for the machining of pre-finished window elements that foresee the work piece repositioning during the machining process.

Available also with manual version (**TV START work table**).

SMART MANAGEMENT

Maestro easyLoad

Ergonomics and easy programming with Maestro easyLoad, which allows easy and dynamic loading and unloading of the work pieces.

accord 500 / accord 600

CNC machining centres for routing and drilling

Simple and quick replacement of clamps and pods by pressing a button, through the exclusive rapid locking device.



MULTRIGRIP (H83) and PROFIGRIP (H145) locking clamps to process elements of different thickness by using double-profile tools, from 45 to 105 mm and from 60 to 120 mm respectively, without any need of manual adjustments.

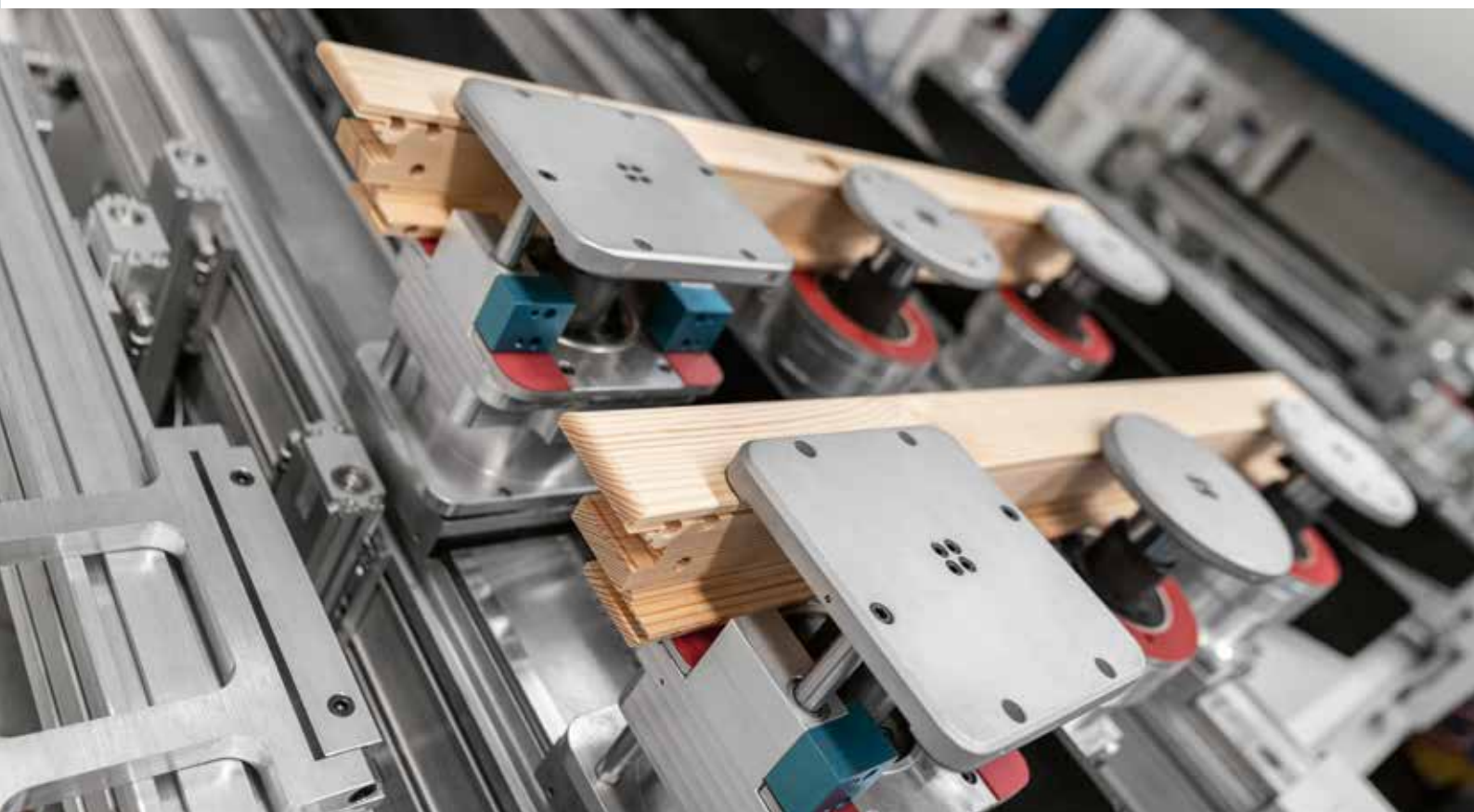

SMART MANAGEMENT

PRODUCING HAS

EASY...

PRODUCTIVITY

Automatic positioning of 2 work pieces according to the machining to be executed

Maestro easyLoad

NEVER BEEN THAT .. AND COMFORTABLE

ERGONOMICS

The operator can easily and ergonomically load
and unload the work pieces

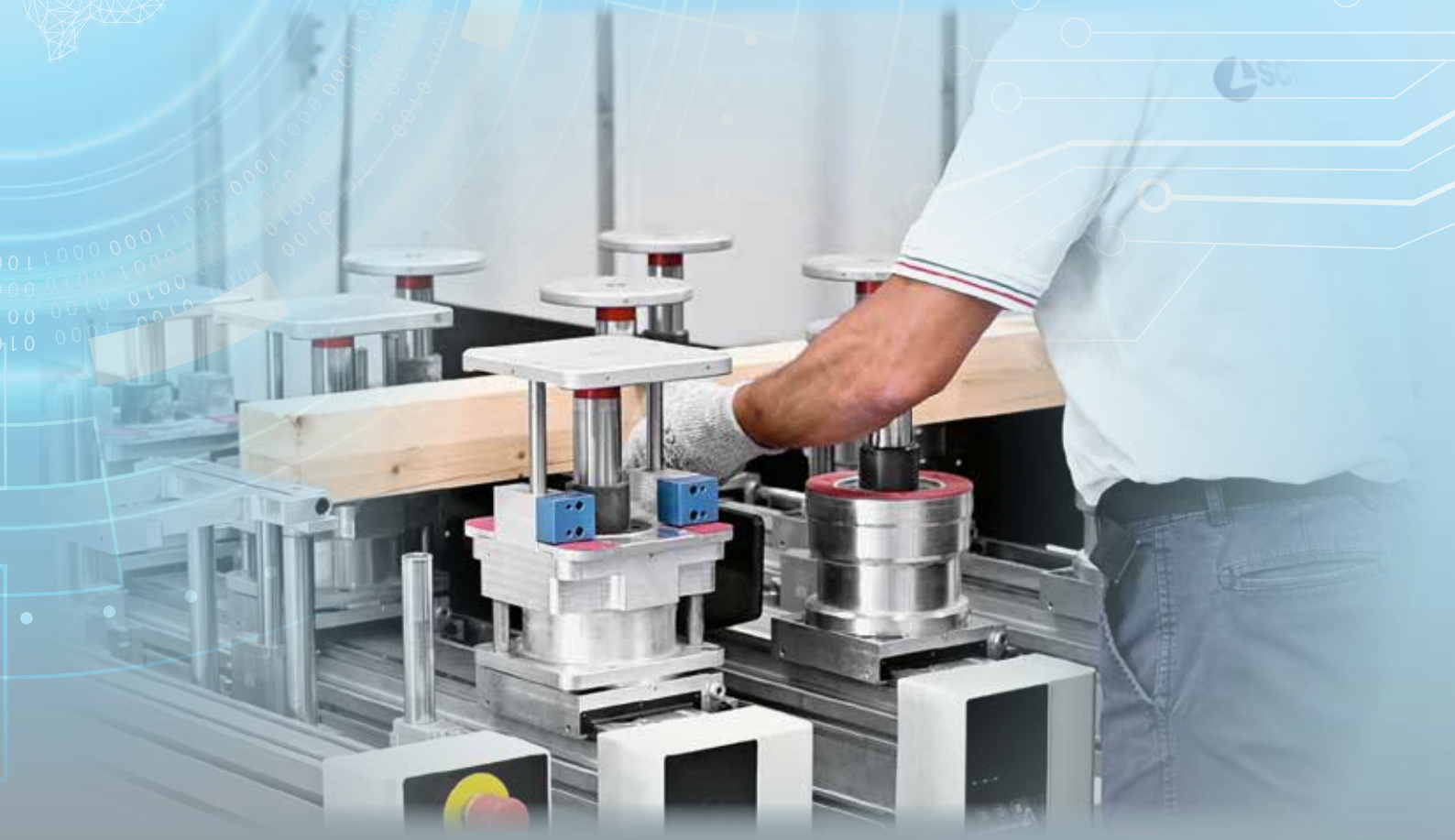

CLEANING SYSTEM

Excellent conditions and maximum cleaning of the machine and of the surrounding environment thanks to the independent positioning of the hood and the deflector device, especially in the most demanding machining operations, which require a heavy material removal.



No problem with dust or shavings thanks to the conveying belt equipped with both a dust extraction hood and a collecting box.



OVERALL DIMENSIONS

accord 500 / accord 600

CNC machining centres for routing and drilling

		A	B		C	
			PRO-SPACE	PRO-SPEED	PRO-SPACE	PRO-SPEED
ACCORD 500						
Working area 3715 x 1600	mm	2990	7830*	8560	5050*	5300
Working area 5515 x 1600	mm	2990	9630*	10360	5050*	5300
Working area 6715 x 1600	mm	2990	10830*	11560	5050*	5300
ACCORD 600						
Working area 3715 x 1600	mm	3020	-	9310	-	6030
Working area 5515 x 1600	mm	3020	-	11110	-	6030
Working area 6715 x 1600	mm	3020	-	12310	-	6030

* It includes the operating area

accord 500
PRO-SPACE

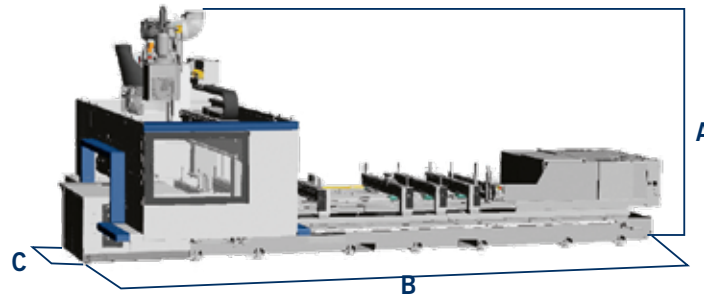

accord 500
PRO-SPEED

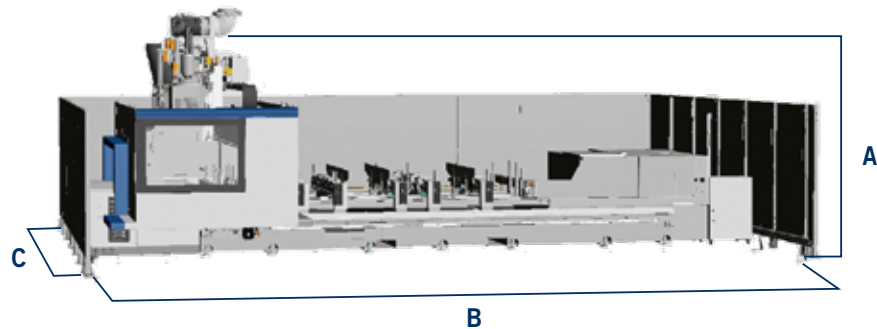

accord 600
PRO-SPEED

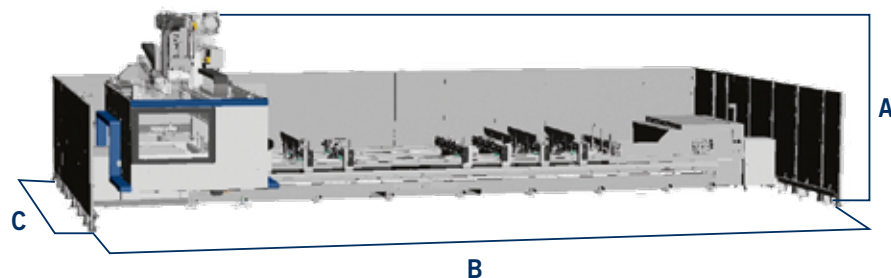

M Maestro Digital Systems

SMART SOFTWARE AND DIGITAL SERVICES TO ENHANCE PRODUCTIVITY OF WOODWORKING AND FURNITURE INDUSTRIES.

design

programming
and data
generation

Maestro office

Office

Factory

Maestro active

cutting



routing
drilling

SOFTWARE

Simple, smart and open Maestro software are tailored on the machine technology as well as on the entire process. All Maestro software share a common mission:

easy to use, so that any operator can easily and confidently learn and use the software

smart, with algorithms and computing modules aiming at the best possible result

open in order to integrate existing software, and provide customer the coverage of all his process.



SCM accompanies woodworking companies throughout their whole process combining machines with matching software solutions and digital services, with a constant strive to enhance company productivity.

The software solutions powered by SCM are developed to optimize machine usage as well as the entire process, providing integration with the different software existing in the company.

DIGITAL SERVICES

Transforming the way it delivers services to its customers through digital technologies and particularly, the IoT platform that collects and analyses data coming from the machine, **SCM created a world of services enabled by Maestro connect.**

Meaning that connecting an SCM machine through Maestro connect will let customer subscribe a program of fast-evolving services and access a wide range of benefits that even go beyond the machine experience and will support and assist you through the whole life-cycle of your machine.

Maestro connect IoT Platform

1
Machine monitoring,
KPIs, early warning

2
Maintenance
equipment

3
Predictive
maintenance

4
Report and historical
data export to MES

5
Warranty
extension

6
Augmented
remote support

7
Smart learning,
SELF-HEALING,
video tutorials

8
Asset management
with e-shop SCM
Spare Parts





Maestro cnc

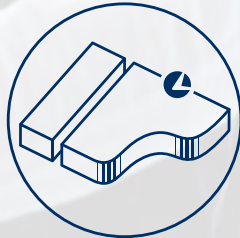

In the office, before the production, the design and programming system Maestro cnc ensures that routing, drilling or sawing can quickly and easily be programmed thanks to 3D graphics of work pieces and machining and clamping aids as well as a smart App and macros library to program any machine operation with a mouse click. Another click away and CNC programs are automatically generated.

SOFTWARE

Office

Maestro cnc

THE SOFTWARE THAT SIMPLIFIES THE WORK

CAD/CAM programming software to design all the production processes. Developed in Windows® environment it ensures easy programming with an advanced, simple and intuitive sketching environment that features all the tools necessary to design the parts, their layout on the work table, tools management and the relative machining operations. All the procedures are contained in a perfectly integrated and high performance software.

ADDITIONAL FUNCTIONS



Maestro pro view - Unique 3D display

3D Simulator that allows users access to a three dimensional model of their machine in their office and view the operations that will be carried out during the production in advance on their PC.



Maestro 3d - Unique in the creation of 3D objects

The module integrated in the Maestro suite is designed to program three dimensional objects on 5-axis machining centres.



Maestro apps - Unique know-how

Maestro apps is a library of programming functions that are always available and easy to use, developed by SCM for the production of parts for doors, windows, stairs, furniture and furnishings.



Maestro msl connector - Total integration

Connector for third-parties with design software.

SPECIALISED MACHINING



Maestro power TMS - Tool Management System

It is the innovative software studied by SCM that simplifies and optimizes tool management. It provides for loading the required tools on the on-board tool changers according to the programs the machine will execute.



Maestro easyLoad - Assisted loading

Ergonomics and easy programming with Maestro easyLoad, which allows easy and dynamic loading and unloading of the work pieces.



Maestro active cnc

Maestro active is the new operator interface software which has been unified across all SCM technologies. A single operator can easily and confidently run multiple machines due to controller and interface consistency: regardless the machine, Maestro active maintains the same look&feel, with many identical icons and navigation buttons, thus ensuring the same approach to interaction.

EASE OF USE

The new interface has been specifically designed and optimized for immediate use via touch screen. Graphics have been redesigned for simple and comfortable navigation, with tablet-like icons on touch screen controller.

“ZERO” ERRORS

Improved productivity thanks to integrated help and recovery procedures that reduce the possibility of error from the operator’s side.

SOFTWARE

Factory

Maestro active cnc

A REVOLUTIONARY APPROACH TO INTERACT WITH YOUR SCM MACHINE

FULL CONTROL OF PRODUCTION PERFORMANCES

The creation of customizable reports by operator, shift, program, forecast period (and much more) allows to monitor, optimize and improve the production performance.

FULL MACHINE AWARENESS AND KNOWLEDGE MANAGEMENT SYSTEM

Maestro active allows to record the times related to setup, maintenance, training and other events, tracing all the activities in a database. The operator’s know-how is also stored and made available to other people inside the organization thanks to the possibility to comment and document all production events or notifications.

ORGANIZE YOUR PRODUCTION

Maestro active allows to create different users with different roles and authorizations (e.g.: operator, maintainer, administrator, ...). Any user can only execute the functions whose permissions have been assigned to him. It is also possible to define the work shifts on the machine and then detect activities, productivity and events that occurred in each shift.

TOTAL QUALITY OF THE FINISHED PRODUCT

With Maestro active the quality of the finished piece is no longer put at risk by worn tools. The new Maestro Active Tool Life Determination system sends notification messages as the tool reaches its end of life and recommends its replacement at the most appropriate time.

TOOLS? NO PROBLEM!

Maestro active guides the operator during the magazine tooling phase, taking into account the programs to be executed.

A WORLD OF SERVICES FOR GREATER EFFICIENCY

Maestro connect

CONNECT YOUR MACHINE AND GAIN ACCESS TO A WORLD OF SERVICES

Connecting your machine through Maestro connect will let you subscribe a program of fastevolving services. You will access a wide range of benefits that even go beyond the machine experience and will support and assist you through the whole life-cycle of your machine.

FASTER SERVICE INTERVENTION AND PROBLEM RESOLUTION

Maestro connect provides real time data and Health Records of the Machine also to SCM Service drastically reducing its troubleshooting time.

WORKING ALWAYS IN PERFECT CONDITIONS

Maestro Connect can provide a full kit of sophisticated sensor devices to detect and warn the operator in case of alarming conditions of the machine.

DIGITAL SERVICES

SMART MAINTENANCE: DOWN TIME REDUCTION

Maestro connect reduces maintenance downtime thanks to:

- Automatic maintenance notifications and scheduling, to prevent failures and work in the best conditions of use
- Direct connection to SCM Service thanks to an automatic ticket opening function

SMART MACHINE: ANYTIME, ANYWHERE AWARENESS

Connecting your SCM machine also means having your machine always at hand. Immediate instant notifications in case of alarms or downtimes allow customers to immediately take an action thus optimizing his productivity.

SMART MANAGEMENT: PRODUCTION PERFORMANCE OPTIMIZATION

Reports and KPIs allow further analysis thus increasing Customer Knowledge about his performance and results.

SMART PARTS: FAST PARTS REPLENISHMENT

Repairs are scheduled proactively since the system provides Spare Parts suggestions and a direct Integration with Smart Parts e-shop.

SMART LEARNING: EXECUTE WORK AND RECEIVE PROBLEM SOLVING SUPPORT

Maestro connect provides an intuitive Problem Solving Management System to help the operator to self solve any issue..

SMARTECH: FASTER AUGMENTED SUPPORT

Maestro connect allows augmented reality support by means of Smartech: the head-wearable computers with wireless connectivity that will bring the interaction between customer and SCM service to a higher level.

SMART WARRANTY: YOUR MACHINE ALWAYS IN PERFECT CONDITIONS

Together with scheduled maintenance contracts, you can take care of your asset by doubling the warranty from 1 year to 2 years* for complete peace of mind!

** please read the complete contract to understand terms and conditions.*

		accord 500	accord 600
AXES			
Vectorial speed X-Y axes "PRO-SPACE" (max.)	m/mm	84	
Vectorial speed X-Y axes "PRO-SPEED" (max.)	m/mm	120	
Z-axis panel passage (max.)	mm	300	
OPERATING UNIT			
3/4 axes			
Electrospindle power (max.)	kW (hp)	21 (28,5)	
Rotation speed (max.)	rpm	24.000	
5 axes			
Electrospindle power (max.)	kW (hp)	17 (23)	13,5 (18,4)
Rotation speed (max.)	rpm	24.000	24.000
DRILLING UNIT			
Independent vertical spindles (up to)	n.	18	18
Independent horizontal spindles (up to)	n.	8	8
Rotation speed (max.)	rpm	8.000	8.000
Integrated blade	∅	125	125
TOOL CHANGERS			
TRB side tool changer	n.	11	11
CADDY side tool changer	n.	35	35
RAPID rear circular tool changer	n.	16	16
TRC rear chain tool changer	n.	32	32
FAST linear tool changer	n.	16	-
VELOCE on-board circular tool changer	n.	16	12+12
INSTALLATION			
Machine weight	kg	6.000 / 8.000	
Exhaust air consumption (max.)	m3/h	5.450	
Compressed air consumption (average)	NI/min	350	



**COMPANY WITH
QUALITY SYSTEM
CERTIFIED BY DNV
= ISO 9001 =**

THE USE OF POWER ONLY WHEN IT IS REQUIRED

SavEnergy allows making things operate only when they are really necessary. It means the machine automatically enters "stand-by" mode when there are no panels to be machined.

The technical data can vary according to the requested machine composition. In this catalogue, machines are shown with options. The company reserves the right to modify technical specifications without prior notice; the modifications do not influence the safety foreseen by the CE Norms.

Maximum noise levels measured according to the operating conditions established by EN 848-3:2012
Acoustic pressure in process (routing) 81 dbA (measured according to EN ISO 11202:2010, uncertainty K = 4 dB)
Acoustic power in process (routing) 98 dbA measured according to EN ISO 3746:2010, uncertainty K = 4 dB)





Even if there is a correlation between above mentioned "conventional" noise emission values and average levels of personal exposure over eight hours of operators, these last also depend on the real operating conditions, duration of exposure, acoustic conditions of the working environment and presence of further noise sources, this means the number of machines and other adjacent processes.

WE'LL GO THE EXTRA MILE FOR YOU



SCM OFFERS A FULL RANGE OF **HIGHLY SPECIALISED SERVICES** WITH A QUALITY AND RELIABILITY THAT STEM FROM OVER 65 YEARS OF EXPERIENCE IN THE INDUSTRY.

From installation and production start-up to services and maintenance. From training to the supply of specific original spare parts: **we provide solutions designed around you!**

 <p>SERVICE AND MAINTENANCE</p> <ul style="list-style-type: none"> • Remote support • Scheduled maintenance contracts • Warranty extension 	 <p>TRAINING SERVICE</p> <ul style="list-style-type: none"> • Courses for machine operators • Software and programming courses • Training in production start-up
 <p>SPARE PARTS</p> <ul style="list-style-type: none"> • Recommended spare parts list • E-shop • Interactive spare-parts catalogues • Repairs on electronic parts, glue tanks and electro-spindles 	 <p>DIGITAL SERVICES</p> <ul style="list-style-type: none"> • Maestro Connect - IoT platform to be constantly connected with your machines • Smartech - assistance with augmented reality • My Scm portal - opening of service ticket and single point of access to the apps and Services tools

CONTACT

SCM SERVICE

via Emilia 77 - 47921 Rimini - Italy
 tel. +39 0541 700100
 scmsservice@scmgroup.com
 www.scmwood.com

SCM SPAREPARTS

Via Casale, 450 - 47826 - Villa Verucchio (RN) - Italy
 tel. +39 0541 674111
 spareparts@scmgroup.com
 www.scmwood.com



THE STRONGEST WOOD TECHNOLOGIES ARE IN OUR DNA

SCM. A HERITAGE OF SKILLS IN A UNIQUE BRAND

Over 65 years of success gives SCM the centre stage in woodworking technology. This heritage results from bringing together the best know-how in machining and systems for wood-based manufacturing. SCM is present all over the world, brought to you by the widest distribution network in the industry.

65+ years history

3 main production sites in Italy

300.000 square metres of production space

20.000 machines manufactured per year

90% export

20 foreign branches

400 agents and dealers

500 support technicians

500 registered patents

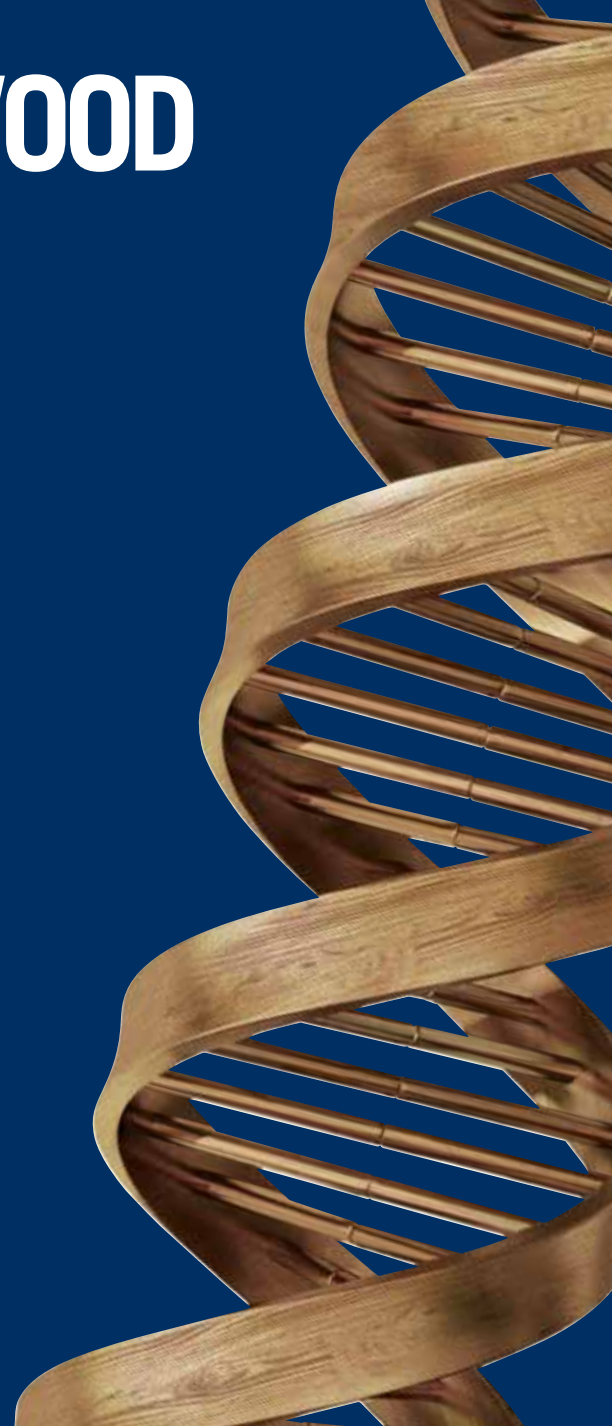

In SCM's DNA also strength and solidity of a great Group. The SCM Group is a world leader, manufacturing industrial equipment and components for machining the widest range of materials.

SCM GROUP, A HIGHLY SKILLED TEAM EXPERT IN INDUSTRIAL MACHINES AND COMPONENTS

INDUSTRIAL MACHINERY

Stand-alone machines, integrated systems and services dedicated to processing a wide range of materials.



WOODWORKING TECHNOLOGIES



TECHNOLOGIES FOR PROCESSING
COMPOSITE MATERIALS, ALUMINIUM,
PLASTIC, GLASS, STONE, METAL

INDUSTRIAL COMPONENTS

Technological components for the Group's machines and systems, for those of third-parties and the machinery industry.



SPINDLES AND
TECHNOLOGICAL
COMPONENTS



ELECTRIC PANELS



METALWORK



CAST IRON



SCM GROUP SPA

via Casale 450 - 47826 Villa Verucchio, Rimini - Italy
tel. +39 0541 674111 - fax +39 0541 674274
morbidelli@scmgroup.com
www.scmwood.com



00L0718131F