

TD55MD - TD55MS

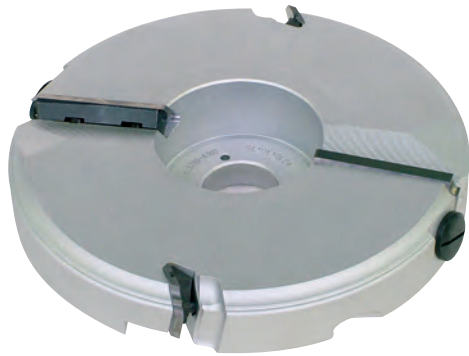

It is possible to fit 5 types of standard knives for machining 5 different profiles (see drawings). Due to the particular tool geometry, this item is particularly indicated for cutting deep profiles.

These items are supplied without knives.

Light alloy body (Aluminum alloy). For cleaning do not use products containing caustic soda.

Con questo utensile si possono ottenere n. 5 tipi di profili diversi (vedi disegni). Possibilità di realizzare specchietti lunghi anche oltre l'albero portautensili (particolarmente utile per l'esecuzione di specchietti per portoni).

Questi articoli vengono forniti senza coltelli.

Corpo in lega leggera (Lega di alluminio). Per la pulizia non utilizzare prodotti contenenti soda caustica.

Raised panel cutterheads Piattabande multiprofilo

D mm	B mm	d* mm	Z	R	Max RPM 1/min.	Code Codice	SAP SAP
210		30	2+2		6.500	TD55MD BA3	F03F668627
210		32	2+2		6.500	TD55MD BC3	F03F668628
210		35 (50)	2+2		6.500	TD55MD BB3	F03FC20217
210		30	2+2		6.500	TD55MS BA3	F03F668629
210		32	2+2		6.500	TD55MS BC3	F03F668630
210		35 (50)	2+2		6.500	TD55MS BB3	F03FC20219

Spare parts Parti di ricambio		Dimensions Dimensioni mm	Code Codice	SAP SAP	
	Screw / Vite	M10 x 25	2602M F19	F03FA07353	
	Screw / Vite	M8 x 10 x 22	VT08M AD9	F03FA04456	
	Screw / Vite	M5 x 7 x 16	VT08M AE9	F03FA04457	
	Allen key / Chiave	5 x 110	CB03M EC9	F03FA00171	
TD55MS TD55MD		Wedge / Cuneo A	21 x 23 x 8	CN55MD AA9A	F03FC24544
		Wedge / Cuneo B	61 x 18 x 8	CN55MD BA9	F03FC01441
		Wedge / Cuneo A	21 x 23 x 8	CN55MS AA9A	F03FC24545
		Wedge / Cuneo B	61 x 18 x 8	CN55MS BA9	F03FC01443

Knives for TD55MD - Coltelli per TD55MD

Profile Profilo	Spare knives Coltelli di ricambio	Dimensions Dimensioni mm	Code Codice	SAP SAP
1	Knife / Coltello A	23 x 24 x 3	CT55MDAA301	F03FC24078
	Knife / Coltello B	65 x 20 x 3	CT55MDBA301	F03FC24087
2	Knife / Coltello A	23 x 24 x 3	CT55MDAB301	F03FC24079
	Knife / Coltello B	65 x 20 x 3	CT55MDBB301	F03FC24088
3	Knife / Coltello A	23 x 24 x 3	CT55MDAC301	F03FC24080
	Knife / Coltello B	65 x 20 x 3	CT55MDBC301	F03FC24089
4	Knife / Coltello A	23 x 24 x 3	CT55MDAE301	F03FC24082
	Knife / Coltello B	65 x 20 x 3	CT55MDBE301	F03FC24091
5	Knife / Coltello A	23 x 24 x 3	CT55MDAF301	F03FC24083
	Knife / Coltello B	65 x 20 x 3	CT55MDBF301	F03FC24092

Knives for TD55MS - Coltelli per TD55MS

Profile Profilo	Spare knives Coltelli di ricambio	Dimensions Dimensioni mm	Code Codice	SAP SAP
1	Knife / Coltello A	23 x 24 x 3	CT55MSAA301	F03FC24096
	Knife / Coltello B	65 x 20 x 3	CT55MSBA301	F03FC24105
2	Knife / Coltello A	23 x 24 x 3	CT55MSAB301	F03FC24097
	Knife / Coltello B	65 x 20 x 3	CT55MSBB301	F03FC24106
3	Knife / Coltello A	23 x 24 x 3	CT55MSAC301	F03FC24098
	Knife / Coltello B	65 x 20 x 3	CT55MSBC301	F03FC24107
4	Knife / Coltello A	23 x 24 x 3	CT55MSAE301	F03FC24100
	Knife / Coltello B	65 x 20 x 3	CT55MSBE301	F03FC24109
5	Knife / Coltello A	23 x 24 x 3	CT55MSAF301	F03FC24101
	Knife / Coltello B	65 x 20 x 3	CT55MSBF301	F03FC24110

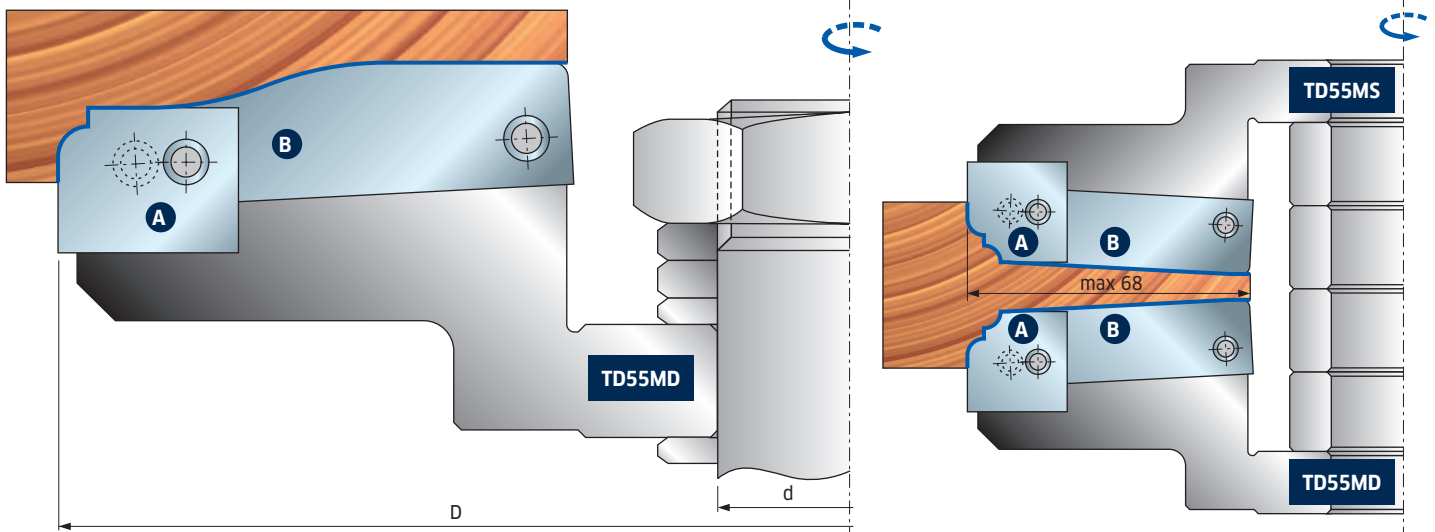

PROFILE / PROFILO 1

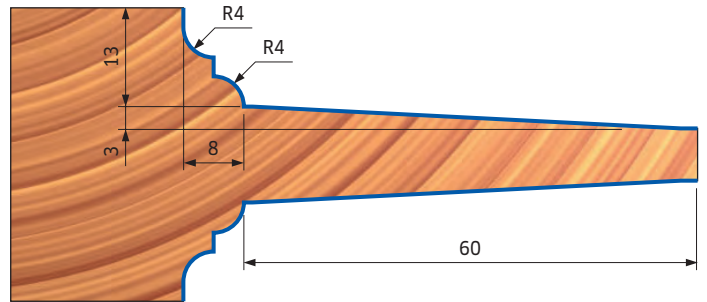
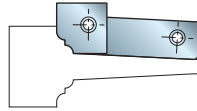
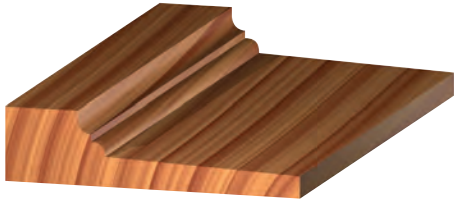

PROFILE / PROFILO 2

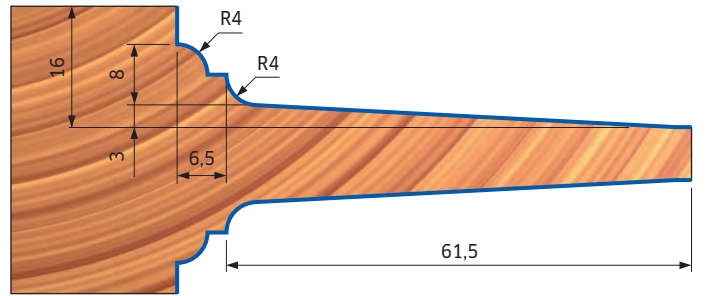
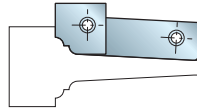

PROFILE / PROFILO 3

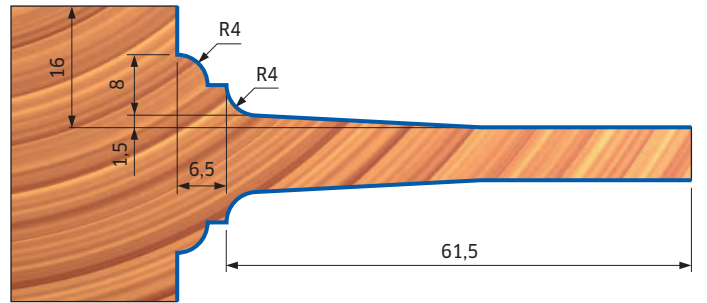
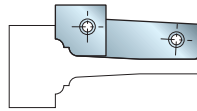
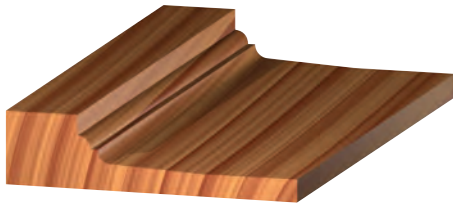

PROFILE / PROFILO 4

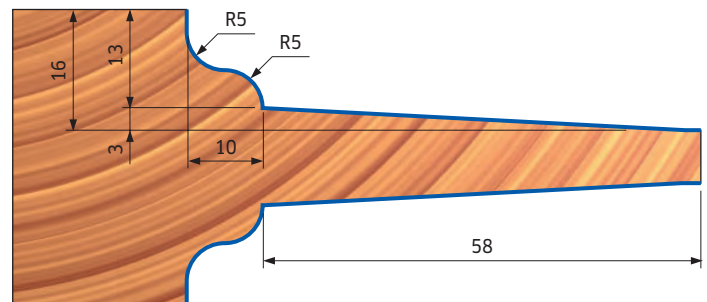
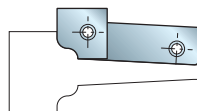

PROFILE / PROFILO 5

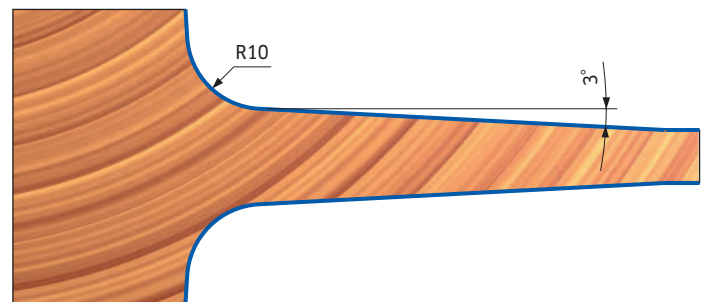
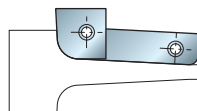
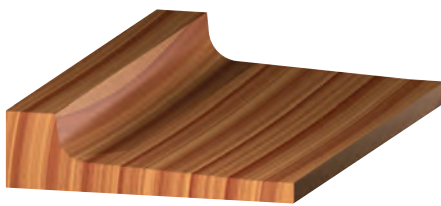

This profile is usable with automatic feed only.
Questo profilo è utilizzabile solamente con avanzamento meccanico.