

HW

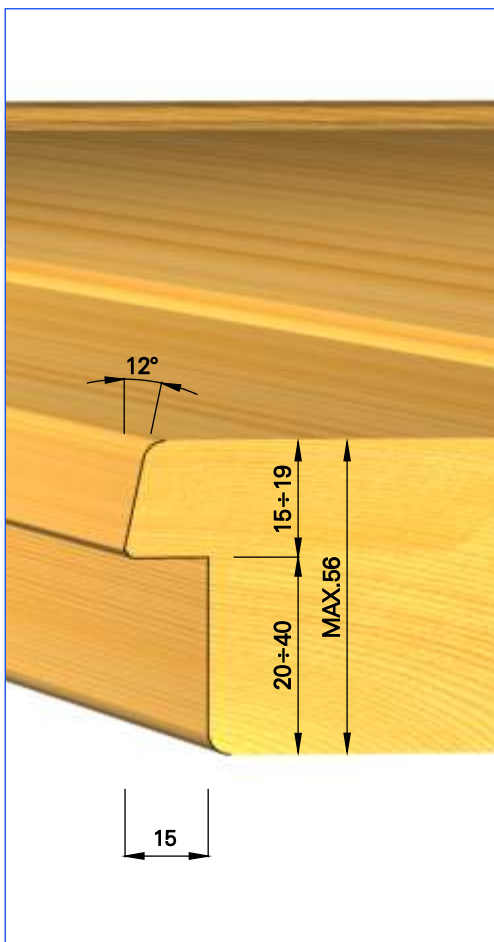









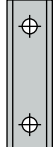

MEC

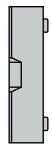
n max 11400

D	d	L1	Z	V	45° COD.	R 1.5 COD.	R 3 COD.
97	30	80	2	2	0623060045	06230600R1	06230600R3

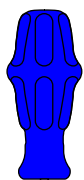
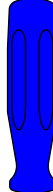

Ricambi / Spare parts / Rechanges / Repuestos / Ersatzteile

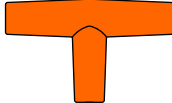
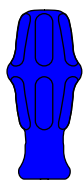
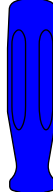
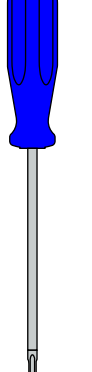
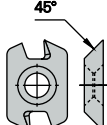
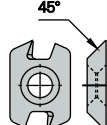
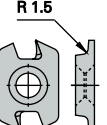
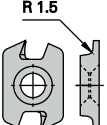
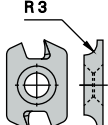
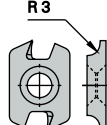
					
COD.	COD.	COD.	COD.	COD.	COD.
0480030014	0480050020	0480050040	0480501800	0480503600	048060C000
					
COD.	COD.	COD.	COD.		
0480700612	0480700620	048074A510	048074B515		
					
COD.	COD.	COD.	COD.	COD.	COD.
048074P350	K48062E000		0480783000	048078T15E	048078T200
					
COD.	COD.	COD.	COD.	COD.	COD.
K480110000	K480120000	K480130000	K480140000	K480150000	K480160000

 Cutter head set on tool holder HSK63F for door profiling.

 Juego de cabezales completo de mandril HSK63F para perfilar puertas.

 Jeu de porte - outils pour calibrage de portes complet d'arbre HSK63F.

 Messerkopfsatz mit Fräsdorn HSK63F für Türenaussenprofil.